



VERSITRIM ONE/200/2000



Engineered Commercial
Roof Edge Systems



BUILDING VALUE



VERSITRIM ONE/200/2000

Versico: Building Value

Versico was formed in 1993 through the acquisition of a major single-ply roofing manufacturer. Now, more than twenty years later, Versico has positioned itself as one of the top single-ply roofing system suppliers in the U.S. by focusing its efforts on quality products and exceptional service.

Versico has been instrumental in the development of today's leading technologies in the commercial roofing industry. With decades of experience in the single-ply roofing field, Versico is able to offer time-tested, proven solutions for your roofing needs.

Versico membranes and roofing systems are rigorously evaluated and tested to ensure that you receive an unmatched roof that will provide years of protection for your valuable assets.

Versico's VersiTrim One/200/2000 Product Line

- VersiTrim 2000 Fascia
- VersiTrim One Edge Fascia
- VersiTrim 2000 Extruded Drip Edge
- VersiTrim 200 & 200 Gold Coping
- VersiTrim 200 Cantilever Coping
- VersiTrim 200 Snap-On Fascia
- VersiTrim 200 Drip Edge
- VersiTrim 200 TPO & PVC Skirted Drip Edge
- VersiTrim 200 Gravel Stop
- VersiTrim 200 Industrial Gutter
- VersiTrim 200 Accessories

Selecting the Ideal Perimeter Edge System for Your Building

The importance of a properly designed roof edge system should not be underestimated. On average, the roof edge typically represents only 1% of a building's overall cost. However, improper design and installation of the roof edge can have catastrophic consequences. Selecting a properly designed and tested metal edge system can diminish the risks and result in a roof system that stands the test of time.

- A quality roof edge system will resist the inward pull of the roof system due to expansion and contraction.
- A quality roof edge system will resist the wind uplift forces that can peel the edge system off the building.

Available Warranties

Versico employs stringent quality assurance protocols to ensure its products meet or exceed the strictest code requirements in the country. Independently tested and certified to withstand high winds, hail, fire, and wind-driven rain, Versico's edge metal is backed by industry-leading warranties, including:

- Versico Total Roofing System Warranty
- A fully transferrable 35-year, Non-Prorated Paint Finish Warranty

For complete information about warranty options, please contact your Versico independent sales representative.



ES-1 Compliant and Certified

Regardless of what level of wind resistance is required, Versico has an edge metal system for the job. Versico's ES-1 compliant edge metal systems are made of premium-quality, heavy-gauge materials and feature pre-punched, engineered cleats that are available in both continuous and segmented lengths. This unique cleat design takes the guesswork out of fastener spacing, prevents sag, and is quick and simple to install.

Versico's edge systems are available in a variety of gauges, colors, and design options.

- Coping widths of 3½" to 32"
- Face dimensions of 2½" to 13"
- Radius trim riveted corners
- Riveted corners
- Welded aluminum corners

What is an ES-1 TESTED Roof Edge System?

The ANSI/SPRI ES-1 Standard is a reference for those who design, specify, fabricate, or install edge materials used with low-slope roofing systems. Based on the information in ASCE 7 Minimum Design Loads for Buildings and Other Structures, the purpose of ES-1 is to improve the longevity and safety of low-slope commercial roofs by incorporating quality edge metal systems.

ES-1 provides calculations and test methods for determining wind uplift pressures on perimeter roof edge terminations, helping to protect the entire system by reducing the risk of edge failure.

VersiTrim Product Comparison Chart

	Product Name	ANSI/SPRI ES-1 Tested and FM Approved	Cleat Material	Installation Method	Maximum Tested Size	Standard Sizes	Custom Size Available	Installed Cost
Premium	VersiTrim 2000 Fascia	✓	Heavy Duty Extruded Aluminum		13" Face	4", 5.5", 7", 8.5", 10", 11.5", 13"	✗	\$\$
	VersiTrim 2000 Drip Edge	✓	Heavy Duty Extruded Aluminum		6" Face	4.5", 6"	✗	\$\$
	VersiTrim 200 Gold Coping	✓	Formed 16 Gauge Steel		12" Face, 32" Wall*	N/A	✓	\$\$\$\$
Preferred	VersiTrim One Fascia	✓	Formed 20 Gauge Steel		8" Face	4", 5", 6.5", 8"	✓	\$
	VersiTrim 200 Snap-On Fascia	✓	Formed 24 Gauge Steel		12.75" Face	5", 6.75", 8.25", 9.75", 11.25", 12.75"	✗	\$\$
	VersiTrim 200 Coping	✓	Formed 20 Gauge Steel		12" Face, 32" Wall*	N/A	✓	\$\$\$
	VersiTrim 200 Cantilever Coping	✓	Formed 16 Gauge Steel		10" Face, 24" Wall	N/A	✓	\$\$\$\$
	VersiTrim 200 Skirted Drip Edge	✓	Formed 22 Gauge Steel		10" Face	2.5", 3", 4", 6"	✓	\$\$
Basic	VersiTrim 200 Gravel Stop	✓	Formed 22 Gauge Steel		10" Face	N/A	✓	\$\$
	VersiTrim 200 Drip Edge	✓	Formed 22 Gauge Steel		10" Face	N/A	✓	\$\$

*Maximum tested wall width of 24" w/12" face. Maximum tested wall width of 32" w/6" face.

VersiTrim 2000 Fascia

Versico's VersiTrim 2000 Fascia is a two-piece assembly that combines superior performance, attractive appearance, and easy installation. This product eliminates the need for stripping-in or heat-welding and provides the maximum available protection against wind damage. VersiTrim 2000 Fascia is also available in extended face sizes (up to 13") and canted cleat versions.

Material: Available in .040" (1.00 mm), .050" (1.25 mm), and .063" (1.60 mm) aluminum and 24-gauge Kynar 500®-coated galvanized steel. The retainer cleat is heavy-duty extruded aluminum with pre-slotted holes for fasteners (provided) to ensure proper placement. VersiTrim 2000 Fascia is available in 12' standard lengths for fewer seams and faster installation.

Available Warranties:

- Versico Total Roofing System Warranty
- Fully transferrable 35-year, Non-Prorated Paint Finish Warranty

Testing: This material has been tested in accordance with ANSI/SPRI/FM-4435 ES-1 Standard for Sustained Wind Speeds per the International Building Code.

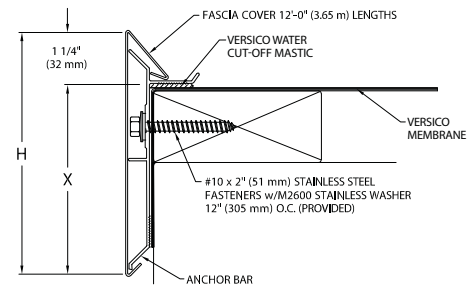
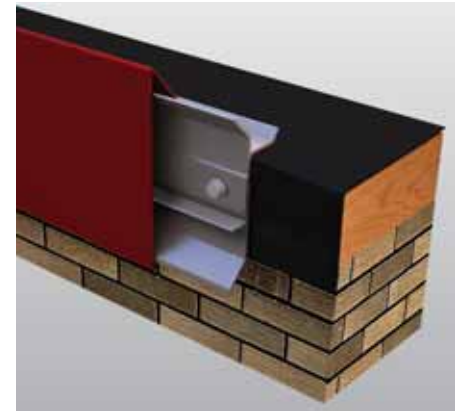

Specifications

Face Height	Coverage	No. of Nailers Covered
4" (102 mm)	2¾" (70 mm)	1
5½" (140 mm)	4¼" (108 mm)	2
7" (178 mm)	5¾" (146 mm)	3
8½" (216 mm)	7¼" (184 mm)	4

VersiTrim One Edge Fascia

Versico's VersiTrim One Edge Fascia is a cost-effective, high-performance product with a minimal lead time. This product eliminates the need for stripping-in or heat-welding, is manufactured and tested to meet ANSI/SPRI ES-1 standards, and is Factory Mutual approved.

Material: Available in .040" (1.00 mm), .050" (1.25 mm), and .063" (1.60 mm) aluminum and 24-gauge Kynar 500-coated galvanized steel. Retainer cleat is available in 20-gauge steel or .050" aluminum with pre-slotted holes for fasteners (provided) to ensure proper placement. VersiTrim One Edge Fascia is available in 12' standard lengths for fewer seams and faster installation.

Available Warranties:

- Versico Total Roofing System Warranty
- Fully transferrable 35-year, Non-Prorated Paint Finish Warranty

Testing: This material has been tested in accordance with ANSI/SPRI/FM-4435 ES-1 Standard for Sustained Wind Speeds per the International Building Code.

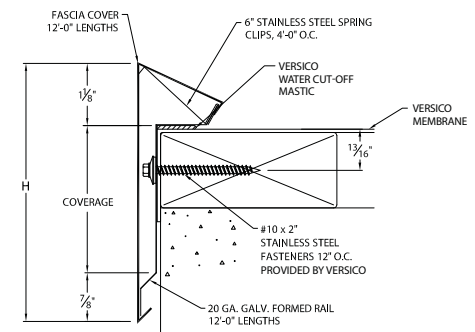
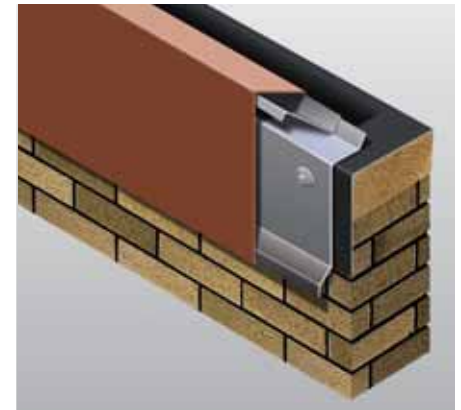

Specifications

Face Height	Coverage	No. of Nailers Covered
4" (102 mm)	2⅞" (73 mm)	1
5" (127 mm)	3⅞" (102 mm)	2
6½" (165 mm)	5⅞" (140 mm)	3
8" (203 mm)	6⅞" (178 mm)	4

VersiTrim 2000 Extruded Drip Edge

Versico's VersiTrim 2000 Extruded Drip Edge features a patented low-profile extruded aluminum anchor bar and a non-penetrating design that eliminates the need for stripping-in or heat-welding. Manufactured in 12' snap-on lengths that do not require crimping, this product is available in a wide variety of colors and finishes.

Material: Available in .040" (1.00 mm) aluminum and 24-gauge Kynar 500-coated galvanized steel. The retainer cleat is heavy-duty extruded aluminum with pre-slotted holes for fasteners (provided) to ensure proper placement. VersiTrim 2000 Drip Edge is available in 12' standard lengths for fewer seams and faster installation.

Available Warranties:

- Versico Total Roofing System Warranty
- Fully transferrable 35-year Non-Prorated Paint Finish Warranty

Testing: This material has been tested in accordance with ANSI/SPRI/FM-4435 ES-1 Standard for Sustained Wind Speeds per the International Building Code.

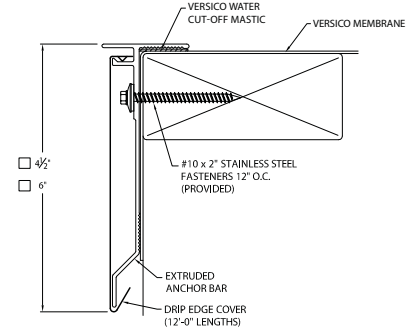
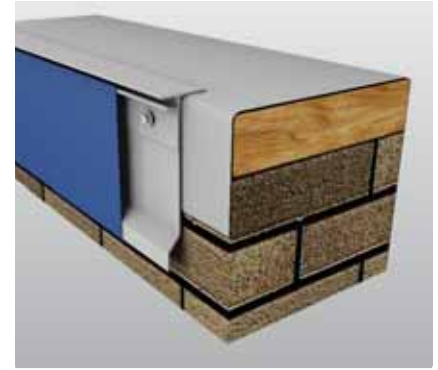

Specifications

Face Height	Coverage	Number of Nailers Covered
4½"	3½"	2
6"	5"	3

VersiTrim 200 & 200 Gold Coping

Versico's VersiTrim 200 Coping's full snap-on design with 20-gauge galvanized steel anchor clips and factory-applied stainless steel springs helps to ensure long-term positive attachment and ease of installation. This product is custom-fabricated to meet job requirements and comes in tapered, flat, and double-tapered profiles. VersiTrim 200 Gold Coping (not pictured) features a heavy-duty 16-gauge galvanized steel cleat for increased wind resistance. All VersiTrim 200 Copings come with 8" concealed splices with dual non-curing butyl sealant strips to prevent water infiltration and allow for thermal movement at joints.

Material: Available in .040" (1.00 mm), .050" (1.25 mm), and .063" (1.60 mm) aluminum and 24-gauge Kynar 500-coated galvanized steel. The retainer cleat is available in 16- or 20-gauge steel with pre-slotted holes for fasteners (provided) to ensure proper placement. VersiTrim 200 Coping is available in 12' standard lengths for fewer seams and faster installation.

Available Warranties:

- Versico Total System Roofing System Warranty
- Fully transferrable 35-year, Non-Prorated Paint Finish Warranty

Testing: This product has been tested in accordance with ANSI/SPRI/FM-4435 ES-1 Standard for Sustained Wind Speeds per the International Building Code.

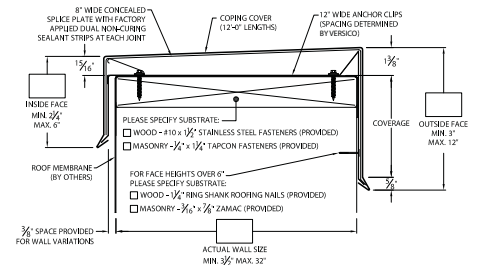
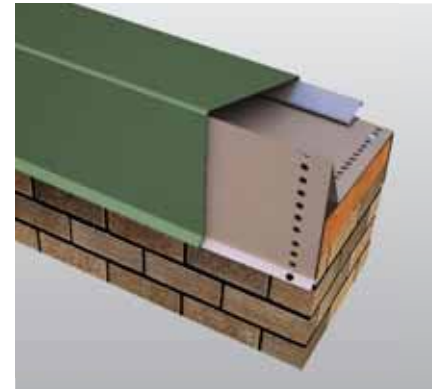

Specifications

Available Sizes	Material & Gauge(s)	Finishes
Wall Size: 3½"-32"	Aluminum: .040"* .050" and .063"	Standard Kynar 500 colors
Outside Face: 3"-12" Inside Face: 2¼"-6"	Galvanized Steel: 24-gauge* Other metals available upon request	Mill finish Anodized aluminum
Miter Leg Length: Std. is Wall Width +9%	*.040 aluminum and 24-gauge steel only available for walls up to 24" wide	Custom or Exotic Kynar 500 Post-Coat finishes and 3-Coat finishes available upon request

VersiTrim 200 Cantilever Coping

Versico's VersiTrim 200 Cantilever Coping is ideal for attachment to parapet walls with a non-structural exterior building facade such as exterior insulation finishing system (EIFS), brick, or panels that don't allow for traditional anchoring to the exterior building structure. This product has unique support brackets that add extra stability to the roof edge system in cases where the attachment is up to 10" away from the outside facade. VersiTrim 200 Cantilever Coping's full snap-on design features 16-gauge galvanized steel anchor clips with factory-applied stainless steel springs and 20-gauge galvanized risers to ensure long-term positive attachment.

Material: Available in .040" (1.00 mm), .050" (1.25 mm), and .063" (1.60 mm) aluminum and 22- and 24-gauge Kynar 500-coated galvanized steel. The retainer cleat is formed from 16-gauge steel with a 20-gauge support bracket with pre-slotted holes for fasteners (provided) to ensure proper fastener placement. VersiTrim 200 cantilever coping is available in 12' standard lengths for fewer seams and faster installation.

Available Warranties:

- Versico Total Roofing System Warranty
- Fully transferrable 35-year, Non-Prorated Paint Finish Warranty

Testing: This product has been tested in accordance with ANSI/SPRI/FM-4435 ES-1 Standard for Sustained Wind Speeds per the International Building Code.

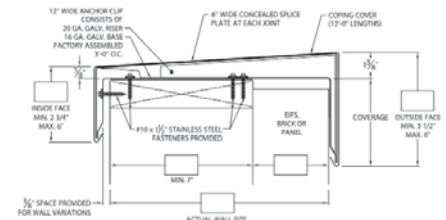
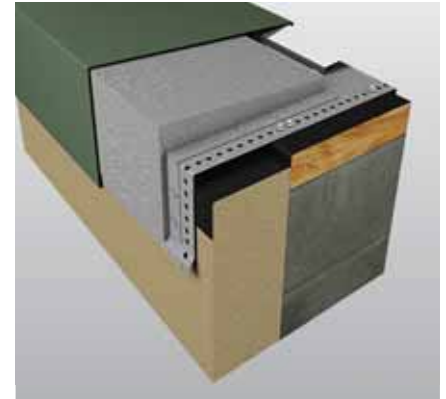

Specifications

Available Sizes	Material & Gauge(s)	Finishes
Wall Size: 8"-32"	Aluminum: .040"* , .050" and .063"	Standard Kynar 500 colors
Outside Face: 3"-12"	Galvanized Steel: 24-gauge*	Mill finish
Inside Face: 2 3/4"-6"	Other metals available upon request	Anodized aluminum
Miter Leg Length: Std. is Wall Width + 9 5/8"	*.040 aluminum and 24-gauge steel only available for walls up to 24" wide	Custom or Exotic Kynar 500 Post-Coat finishes and 3-Coat finishes available upon request

VersiTrim 200 Snap-on Fascia

Versico's VersiTrim 200 Snap-On Fascia features a snap-on cover that eliminates crimping, substantially reducing installation time. The canted cleat design creates a water dam at the perimeter of the roof and can also help to keep stone in place on ballasted roofs. Dual attachment points on both the face and horizontal surface allow for added flexibility when accommodating roof irregularities.

Material: Available in .040" (1.00 mm), .050" (1.25 mm), and .063" (1.60 mm) aluminum and 24-gauge Kynar 500-coated galvanized steel. The retainer cleat and spring clips are formed from 24-gauge steel with pre-slotted holes for fasteners (provided) to ensure proper placement. VersiTrim 200 Fascia is available in 12' standard lengths for fewer seams and faster installation.

Available Warranties:

- Versico Total Roofing System Warranty
- Fully transferrable 35-year, Non-Prorated Paint Finish Warranty

Testing: This product has been tested in accordance with ANSI/SPRI/FM-4435 ES-1 Standard for Sustained Wind Speeds per the International Building Code.

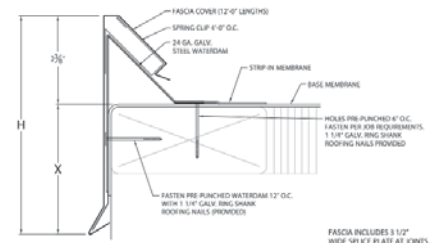
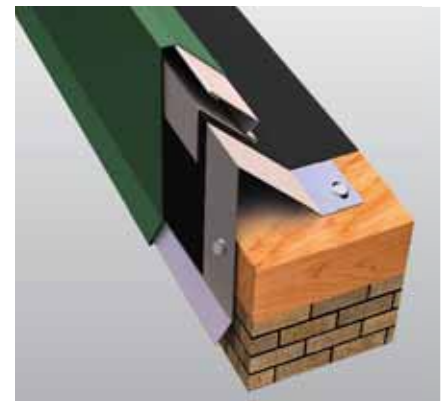

Specifications

Face Height	Coverage	No. of Nailers Covered
5 1/4" (133 mm)	2 7/8" (73 mm)	1
6 3/4" (171 mm)	4 3/8" (111 mm)	2
8 1/4" (210 mm)	5 3/8" (149 mm)	3
9 3/4" (248 mm)	7 3/8" (187 mm)	4
11 1/4" (286 mm)	8 7/8" (225 mm)	5
12 3/4" (324 mm)	10 3/8" (264 mm)	6

VersiTrim 200 Drip Edge

Versico's VersiTrim 200 Drip Edge is a two-part assembly that consists of an L-shaped continuous cleat and a decorative cover with pre-slotted fastening holes on the roof flange. Once the cleat and cover are fastened, the drip edge can be stripped-in using Versico Quick-Applied Cured Cover Strip and Primer, or heat-welded if TPO or PVC coated metal is used.

Material: Available in .040" (1.00 mm), .050" (1.25 mm), and .063" (1.60 mm) aluminum and 24-gauge Kynar 500-coated galvanized steel, as well as 24-gauge VersiWeld® TPO and VersiFlex™ PVC coated steel. The retainer cleat is formed from 22-gauge steel with pre-slotted holes for fasteners (provided) to ensure proper placement. VersiTrim 200 Drip Edge is available in 12' standard lengths for fewer seams and faster installation.

Available Warranties:

- Versico Total Roofing System Warranty
- Fully transferrable 35-year, Non-Prorated Paint Finish Warranty

Testing: This product has been tested in accordance with ANSI/SPRI/FM-4435 ES-1 Standard for Sustained Wind Speeds per the International Building Code.

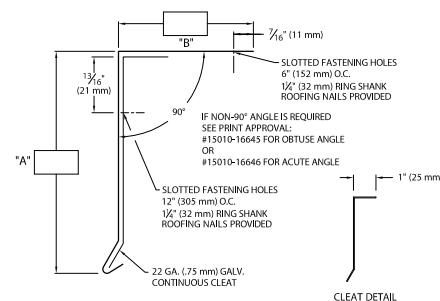
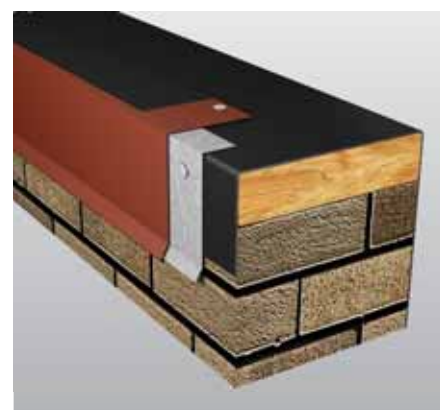

Specifications

Cleat	Coverage
22-gauge galvanized steel	Up to 9¾"

VersiTrim Skirted Heat-Weldable TPO & PVC Drip Edge

Versico's VersiTrim Skirted Heat-Weldable Drip Edge features a 60-mil (1.52 mm), 6"-wide, factory-hot-welded TPO or PVC membrane flashing skirt for a quicker installation and a high-quality, consistent weld between the coated metal and the flashing material. VersiTrim 200 TPO & PVC Drip Edges are manufactured in 12' lengths and feature pre-slotted fastening holes that allow for proper thermal movement of materials.

Material: Available in 24-gauge VersiWeld TPO and VersiFlex PVC coated steel. The retainer cleat is formed from 22-gauge steel with pre-slotted holes for fasteners (provided) to ensure proper placement. VersiTrim Drip Edge is available in 12' standard lengths for fewer seams and faster installation.

Available Warranties:

- Versico Total Roofing System Warranty
- Fully transferrable 35-year, Non-Prorated Paint Finish Warranty

Testing: This product has been tested in accordance with ANSI/SPRI/FM-4435 ES-1 Standard for Sustained Wind Speeds per the International Building Code.

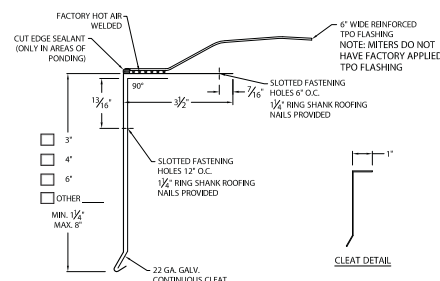
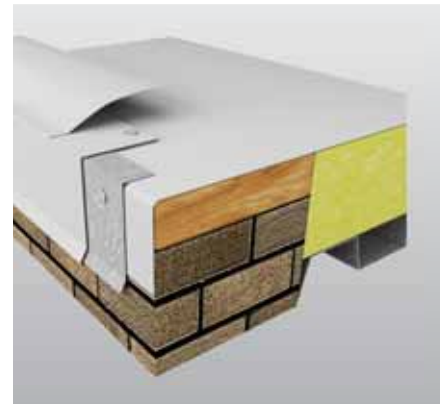

Specifications

Standard Face Size	Material	Flashing Membrane
3"	24-gauge VersiWeld TPO Coated Steel or VersiFlex PVC Coated Steel	6"-wide reinforced VersiWeld TPO or VersiFlex PVC
4"		
6"		

Also available in custom sizes 1¼"-8"

VersiTrim 200 Gravel Stop

Versico's VersiTrim 200 Gravel Stop's two-part assembly consists of an L-shaped continuous cleat and a decorative cover with pre-slotted fastening holes on the roof flange. Once the cleat and flange are fastened, the gravel stop can be stripped-in using Versico's Quick-Applied Cured Cover Strip and Primer. The rise at the edge of the roof is customizable (minimum of 1/2" high)

Material: Available in .040" (1.00 mm), .050" (1.25 mm), and .063" (1.60 mm) aluminum and 24-gauge Kynar 500-coated galvanized steel. The retainer cleat is formed from 22-gauge steel with pre-slotted holes for fasteners (provided) to ensure proper placement. VersiTrim 200 Gravel Stop is available in 12" standard lengths for fewer seams and faster installation.

Available Warranties:

- Versico Total Roofing System Warranty
- Fully transferrable 35-year, Non-Prorated Paint Finish Warranty

Testing: This product has been tested in accordance with ANSI/SPRI/FM-4435 ES-1 Standard for Sustained Wind Speeds per the International Building Code.

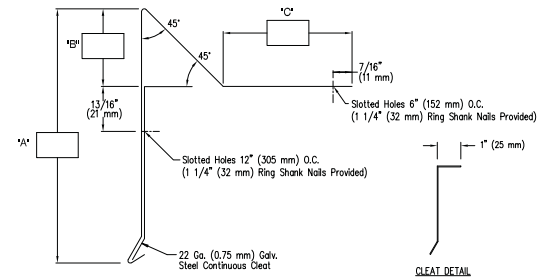

Specifications

Cleat	Coverage
22-gauge galvanized steel	Up to 8 3/4"

VersiTrim 200 Industrial Gutter

Versico's VersiTrim 200 Gutter systems come in three styles: Offset, Chamfer (pictured), and Box. This product features a unique aluminum gutter strap design which eliminates the need for drilling and riveting. The free-floating, hook-in strap allows for full thermal movement of the gutter. Offered with an optional roof flange or slotted drain bars for ballast retention, this product facilitates maximum roof drainage.

Material: Available in .040" (1.00 mm), .050" (1.25 mm), and .063" (1.60 mm) aluminum and 24-gauge Kynar 500-coated galvanized steel. The gutter hangers are made from heavy .100-mil aluminum. VersiTrim 200 Industrial Gutter is available in 12' standard lengths for fewer seams and faster installation.

Available Warranties:

- Versico Total Roofing System Warranty
- Fully transferrable 35-year, Non-Prorated Paint Finish Warranty

Testing: This product has been tested in accordance with ANSI/SPRI/GT-1 Standard for Sustained Wind Speeds with optional support bracket.

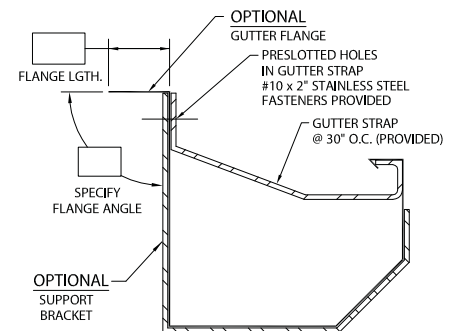
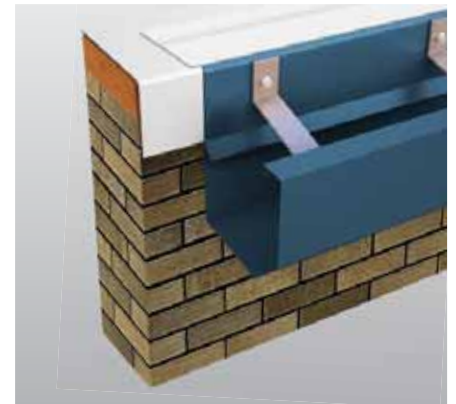

Specifications

Standard Size	Available Styles
6"	
7"	IG-1: Offset
8"	IG-2: Chamfer
9"	IG-B: Box

Versico's VersiTrim Accessories

Counter Flashing

VersiTrim 200 Counter Flashing is available in five different configurations: one-piece surface mount, one-piece reglet, two-piece surface mount, two-piece reglet, and two-piece thru-wall. All are available in 24-gauge steel and .040" and .050" aluminum.

Water Control Accessories

Versico offers a variety of water control accessories, including: Thru-Wall Scuppers, Collector Boxes, Downspouts, and custom Brick Wall Caps. All products are offered in a variety of materials, thicknesses, and colors which can be customized to meet project-specific requirements.

Termination Bar Fascia

VersiTrim 200 Termination Bar Fascia consists of a 1.75"-wide, .063" aluminum Termination Bar with snap-on decorative cover and is available in .040" aluminum or 24-gauge Kynar 500-coated galvanized steel.

Two-Piece Thru-Wall Counter Flashing

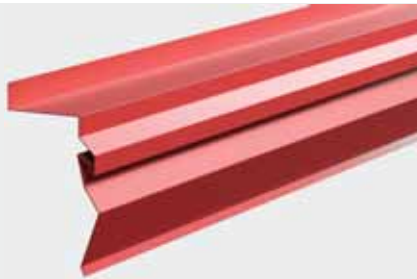

Thru-Wall Scupper with Collector Box



Closed Face Downspout



Termination Bar Fascia

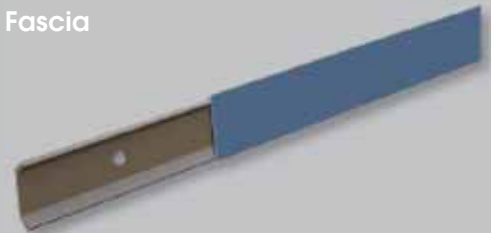







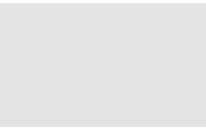
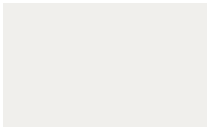

Minimum Metal Thickness for Flatness

When selecting a metal roof edge system it is important to consider the height of the face and the type of metal being used. The table below is a recommendation from ANSI/SPRI/FM-4435 ES-1 for selecting the right metal thickness. Using the proper metal type and thickness will ensure performance, reduce the risk of oil canning, and result in an aesthetically pleasing look.

Exposed Face	Galvanized Steel	Cold Rolled Copper	Formed Aluminum	Stainless Steel
Up to 4" (100 mm)	24 ga (0.028" and 0.7 mm)	16 oz (0.022" and 0.6 mm)	0.040" (1.0 mm)	26 ga (0.016" and 0.4 mm)
> 4" -8" (>100-200 mm)	24 ga (0.028" and 0.7 mm)	16 oz (0.022" and 0.6 mm)	0.050" (1.3 mm)	26 ga (0.016" and 0.4 mm)
> 8" -10" (>200-250 mm)	22 ga (0.034" and 0.9 mm)	20 oz (0.027" and 0.7 mm)	0.063" (1.6 mm)	24 ga (0.023" and 0.6 mm)
> 10" -16" (>250-400 mm)	20 ga (0.040" and 1.0 mm)	20 oz with stiffening ribs	0.080" (2.0 mm)	22 ga (0.029" and 0.7 mm)

VersiTrim 200/2000 Series Color Chart









Express Colors (Also in Mill Finish)

				
Stone White*	Bone White*	Almond*	Sandstone*	Cityscape*
				
Slate Gray*	Sierra Tan*	Medium Bronze*	Dark Bronze*	Clear Anodized

Standard Colors

				
Charcoal*	Midnight Bronze	Matte Black	Burgundy	Terra Cotta*
				
Cardinal Red*	Military Blue*	Interstate Blue	Teal*	Patina Green*
				
Hartford Green	Hemlock Green*	Colonial Red*	Forest Green	Mansard Brown*
				
Granite*	Musket Gray*	Evergreen*	Hunter Green*	Slate Blue*

Premium Colors

				
Copper Penny*	Silver*	Champagne*	Zinc*	Weathered Zinc*
				
Aged Copper*	Silversmith	Award Blue		

*ENERGY STAR® Rated

Colors shown are representative of the prefinished KYNAR colors but not exact matches. Actual metal color chips are available upon request and should be used for final color approval.

Quick Reference Guide

Color Name	Hylar 5000 / Kynar 500				
	24 ga.	22 ga.	.040"	.050"	.063"
Almond	♦	♦	♦	♦	♦
Bone White	♦	♦	♦	♦	♦
Burgundy	♦		♦	♦	
Charcoal	♦	♦	♦	♦	
Cityscape	♦	♦	♦	♦	
Colonial Red	♦	♦	♦	♦	
Dark Bronze	♦	♦	♦	♦	♦
Midnight Bronze	♦	♦	♦	♦	
Evergreen	♦				
Forest Green	♦	♦	♦	♦	
Granite	♦	♦	♦	♦	
Hartford Green	♦		♦	♦	
Hemlock Green	♦		♦	♦	
Hunter Green	♦				
Mansard Brown	♦	♦	♦	♦	
Matte Black	♦	♦	♦	♦	♦
Medium Bronze	♦	♦	♦	♦	♦
Musket Gray	♦	♦		♦	
Patina Green	♦		♦	♦	
Interstate Blue	♦	♦	♦	♦	
Cardinal Red	♦		♦	♦	
Military Blue	♦	♦	♦		
Slate Blue	♦				
Slate Gray	♦	♦	♦	♦	
Sandstone	♦	♦	♦	♦	♦
Sierra Tan	♦	♦	♦	♦	♦
Stone White	♦	♦	♦	♦	♦
Teal	♦		♦		
Terra Cotta	♦		♦	♦	
Premium					
Champagne	♦	♦	♦	♦	
Copper Penny	♦		♦	♦	
Silver	♦	♦	♦	♦	♦
Zinc	♦		♦	♦	
Weathered Zinc	♦	♦		♦	
Aged Copper	♦			♦	
Silversmith			♦		
Award Blue	♦			♦	
Coil Anodized					
Black			♦	♦	♦
Clear			♦	♦	♦
Dark Bronze			♦	♦	♦
Light Bronze			♦	♦	♦
Other					
Mill Finish (3003-H14)	.040, .050, .063, .080, .100, .125				
110 Copper	16 oz. & 20 oz.				
304-2B Stainless Steel	20 ga., 22 ga. & 24 ga.				
Galvanized Steel	16 ga., 20 ga., 22 ga. & 24 ga.				
Galvalume Plus	22 ga., 24 ga.				
Paint Grip	22 ga., 24 ga.				

Please Note

Express colors available in shorter lead times for 24 ga., .040" and .050" only. Standard lead times, which may be longer, apply for 22 ga. and .063".

Protective film must be removed immediately. Please note this chart is only a representation of color options. Color matches should only be made with actual samples. Please call or write for actual metal sample(s). Customer is responsible for color selections chosen from printed literature.

We receive metal through multiple vendors. If a specific metal vendor is required for a project, please specify this at the time of order.

Kynar 500® based fluoropolymer coating is a high-grade architectural finish offering excellent resistance to degradation caused by nature's elements and airborne contaminants. A limited thirty (30) year finish warranty is available on the prefinished coil-coated steel and aluminum colors shown. Restrictions may apply; consult a sales representative for specific information.

Standard anodized finishes that utilize a continuous coil anodizing process to provide excellent color consistency from piece to piece are available. However, shade variations may occur from coil batch to coil batch. Class I batch anodizing is also available.

As noted, many colors are ENERGY STAR rated. Emissivity uses ASTM C1371. Reflectivity uses ASTM C1549.



A SINGLE SOURCE FOR SINGLE-PLY ROOFING

800.992.7663 • www.versico.com